



FORTINET® PROTECT

MANUAL FOR ERECTING FORTINET PROTECT FENCE

EN

Table of contents

1. The Betafence concept.	3
1.1 Post system.	3
1.2 Tools for professional installation	3
2. Preparation of the perimeter fence line	4
3. Embedding the posts into the concrete	6
4. Installation of the mesh	7
5. To continue	10
6. Supplementary fixation.	10
7. Supplementary indications to keep in mind	11
8. Reparation of fortinet welded mesh	17
8.1 Tools.	17
8.2 Procedure	17
9. Fixing of Y-extension arms with barbed wire and clipped razor tape on Bekaclip posts	20
A. Fixation of the Y-extension arms on straight posts.20
B. Fixation of the barbed wire on the Y-extension20
C. Installation & fixation of the concertina coil on top of the Y-extension arms21

1. THE BETAFENCE CONCEPT

POST SYSTEM

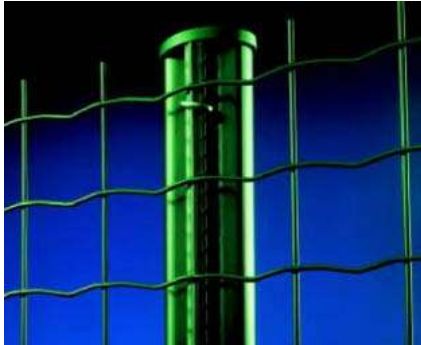

Professional Bekaclip posts

The welded mesh is fixed to the posts using stainless steel fixing clips.

TOOLS FOR PROFESSIONAL INSTALLATION



Tension comb

For even distribution of the tension across the welded mesh.
For netting 1,50 meter to 2 meter high.

Clip tongs

For fixing the clips to the attachment strips on the posts.

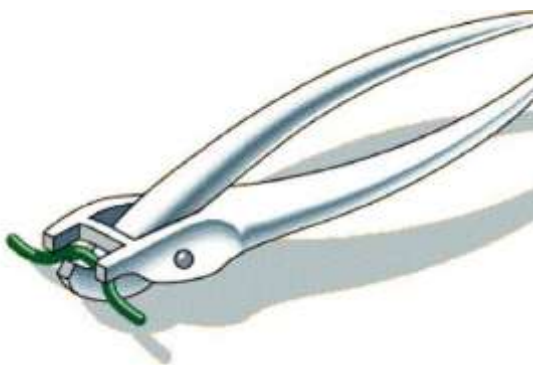
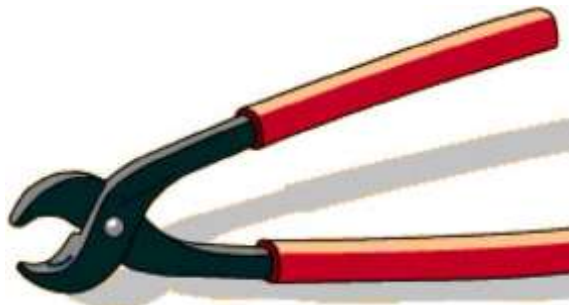

Crimping tongs

For adjusting the tension
(increases the crimping in the horizontal wires of the mesh)

2. PREPARATION OF THE PERIMETER FENCE LINE

Level the fence line as much as possible over a width of about 3 meter and over the total length: endless undulations make the erecting of the fence very difficult.

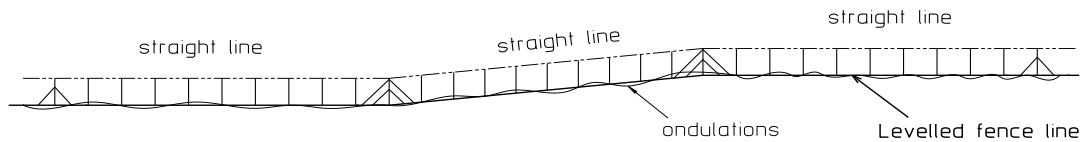

Normal ground constitution

Holes can be drilled by means of a drill screwed on an excavator: see dimensions as indicated on attached shopdrawing.

Sandy ground

Work with precast concrete foundation blocks (off-site or "in sito")
 Make full slots following the fence line and install the foundation blocks.
 Fill up the slot with back fill, gravel or something alike. Level the area in front (=outside the property) over about 3 meter.

Hard rocky ground

Drill holes with diameter +/- 20 cm, 60 cm deep by means of an adapted widia drill screwed on an excavator: posts can be shortened.
 After putting the postst in the holes fill up the holes with rigid liquid concrete.

In areas where there is water accumulation

Depending on the dept, use longer posts or check the possibility to put the fence on another track.

Important note:

- Take at least one week for hardening of the concrete
- Make wet several times a day and protect against sunshine especially when temperatures are high
- We advice to use concrete as dry as possible

Sample of a property

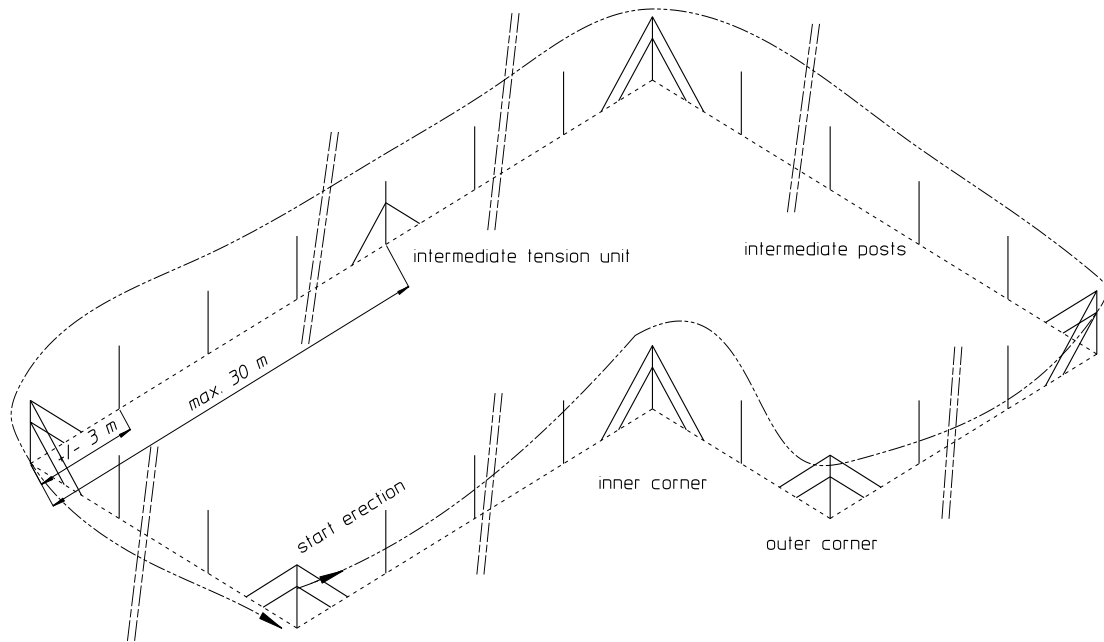

Inner- and outer corners

Verify the details related to the direction of the fixing strip on the post when making inner- and outer-corners.

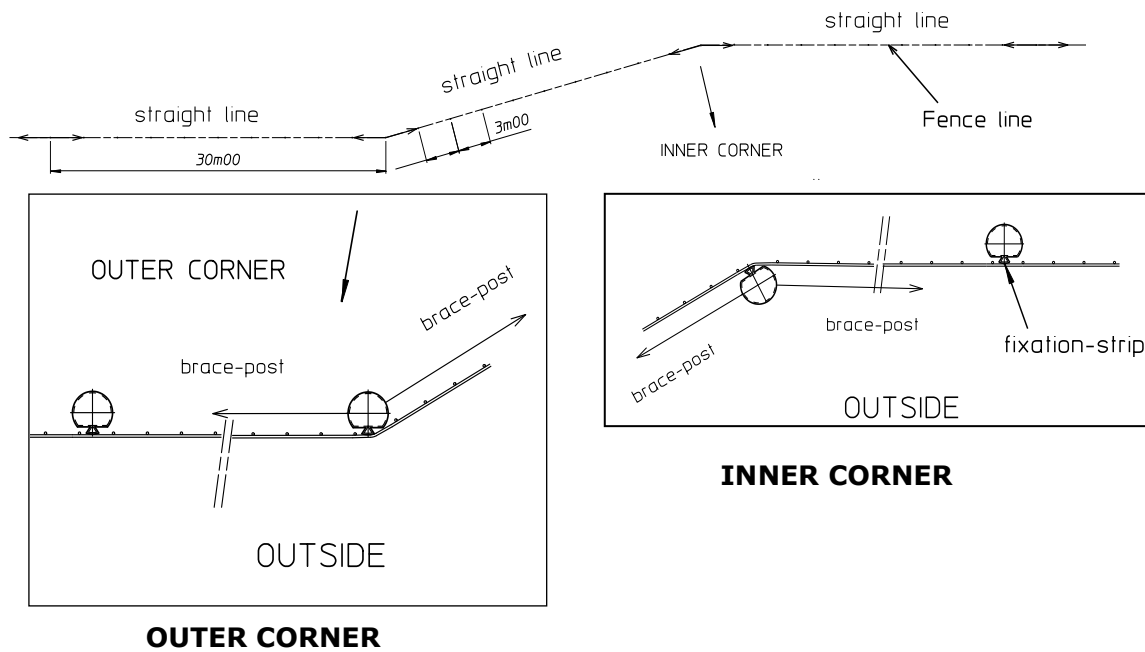

3. EMBEDDING THE POSTS INTO THE CONCRETE (+ ONE WEEK FOR HARDENING)

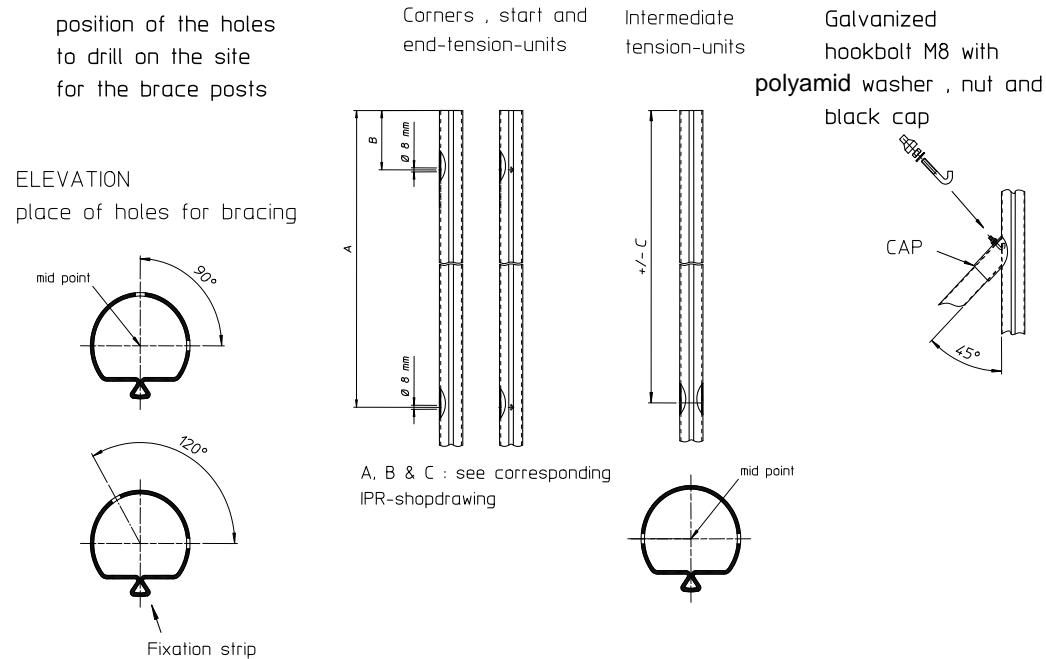

STEP 1

Start embedding the corner-, first- and end- posts and the intermediate tension posts first, together with the brace posts.

STEP 2

Fix the brace posts properly: each hole has to be directed to the mid point of the Bekaclip post; screws have to be fixed properly. Holes diameter 8 mm for hook bolts to be drilled on site/off site by a contractor.

STEP 3

Tension a rope from top to top of these tension units and embed the intermediate posts properly whilst touching the rope on top of the intermediate posts to ensure the right level and direction.

4. INSTALLATION OF THE MESH

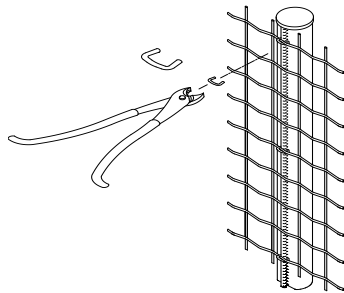

Bekaclip post with Bekaclip tong and stainless steel clips

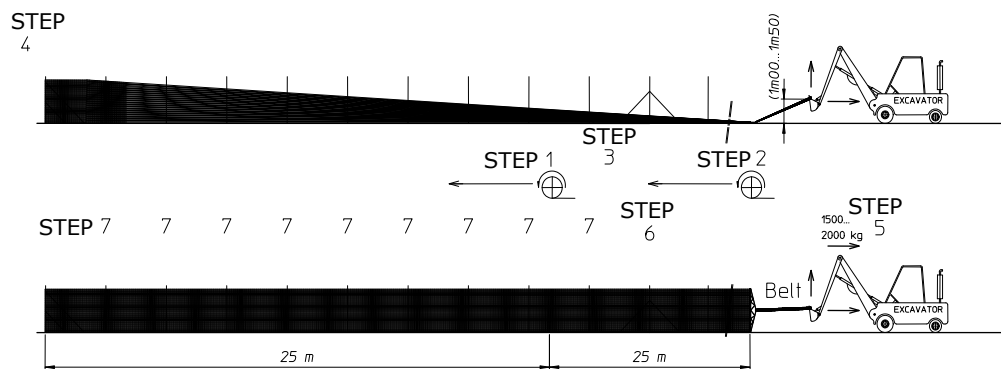

STEP 1 & STEP 2

Unroll two Fortinet Protect rolls over the ground in front of the posts.

STEP 3

Connect them by means of the Fortinet clips.

JUNCTION OF TWO ROLLS :
fix each horizontal wire

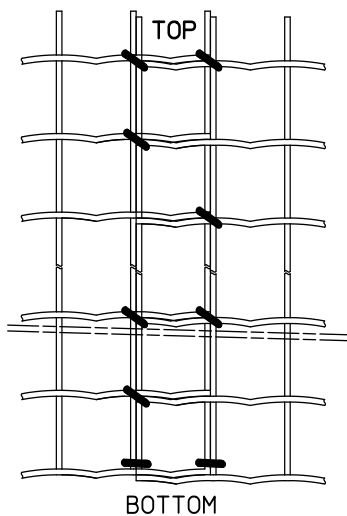

STEP 4

Lift up the start of the roll and fix on the first post.

Fix each horizontal wire to start.
Horizontal wires of the welded mesh on the outside of the property.

FIRST TENSION POST :
fix each horizontal wire

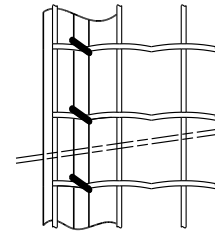
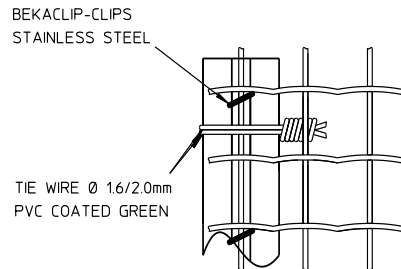

The overhangs directed to the top of the fence.

at the top, on the bottom and in the middle b.m.o. knotted double tie wire

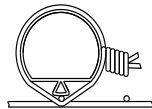

Secure the fixation by means of double knotted tie wire all over the height of the fence.

STEP 5

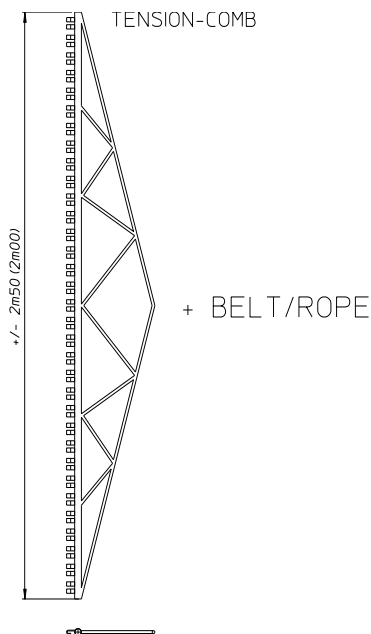

Insert the tension comb in the welded mesh a couple of meters over the first intermediate tension unit (at least 30 meter away from the first post).

Hang on the belt/rope between tension comb and the scoop of the excavator and start tensioning. The welded mesh will lift up by itself.

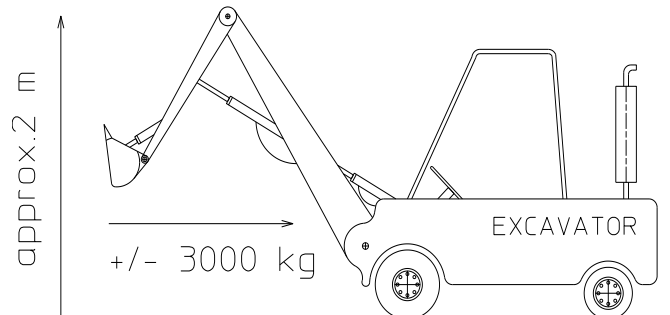

STEP 6

TENSION POST : (brace-units)
fix at least each 30 cm
(even corner-posts)

Once you have full tension (= welded mesh is perfectly straight and "feels hard", fix the roll on the fixation strip of the tension post with clips about each 30 cm.

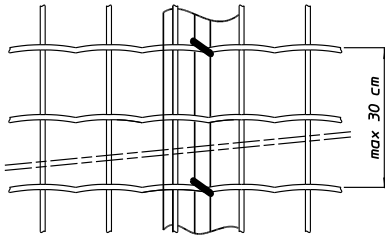

OR

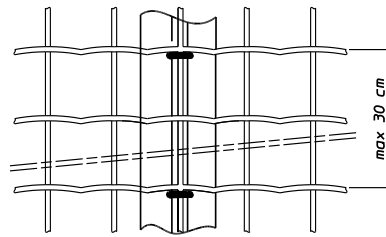

Verify the distance between the lower part of the roll and ground level before fixing properly.

STEP 7

Do the same on each intermediate post: distance between two clips is about 40 cm.

Check height above ground level on each post before fixing.

INTERMEDIATE POST :
fix at least each 40 cm

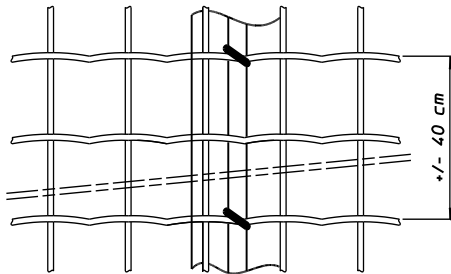

OR

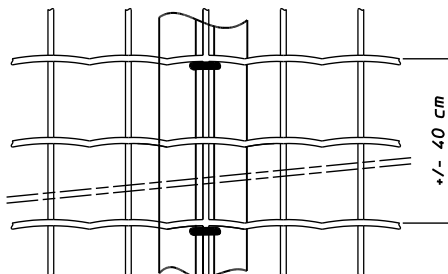

5. TO CONTINUE

Once the first 30 linear meter are installed properly, untension the tension comb and the belt/rope.

Connect 2 or 3 new rolls on the first end and tension by means of the tension comb, the belt and the excavator.

Always check the distance between welded mesh and ground level and make yourself pleased with the tension on the welded mesh before fixing.

Always fix the mesh first on the tension units (step 6 each +/- 30 linear meter) and later on the intermediate posts (step 7) .

JUNCTION OF TWO ROLLS :
fix each horizontal wire

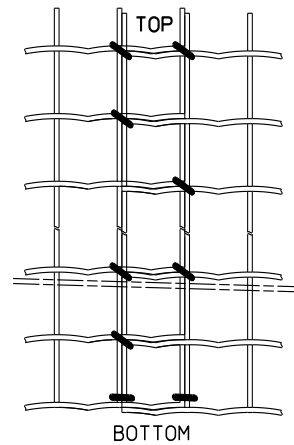

6. SUPPLEMENTARY FIXATION

Supplementary double tie wire can be added afterwards and knotted on the inside of the property. We advice once at the top, once at the bottom and once in the middle of the welded mesh.

7. SUPPLEMENTARY INDICATIONS TO KEEP IN MIND

1. We advise to start erecting the fence on a normal, flat and horizontal ground level to learn and to feel how to handle .
2. Inner and outer corners
It is very important to think about the position of the fixation strip of the Bekaclip posts before embedding them into the concrete, see the details. Also think about the direction of tensioning before embedding and drilling the corner posts: sometimes it can be better to turn the post over 90°. Ensure yourself before starting.
3. Slopes

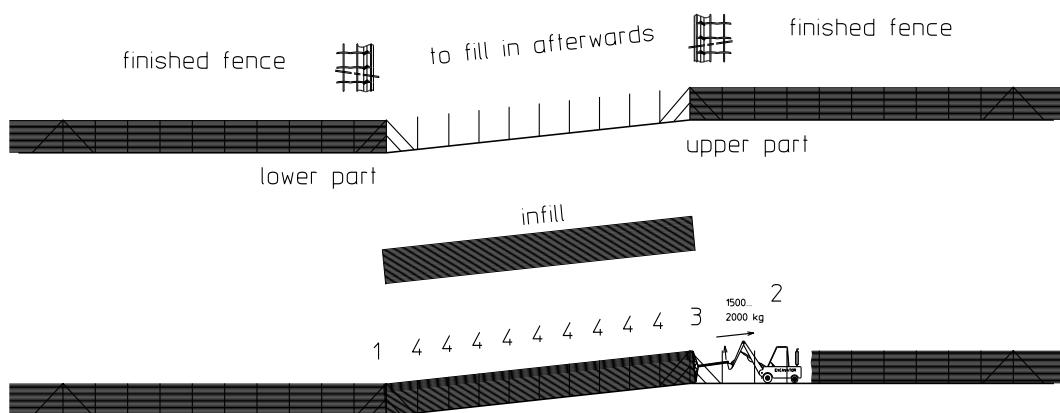

- Foresee tension units each time the fence changes direction, horizontally as well as vertically.
- Fix lower and upper part of the fence properly on the tension units .
- Cut of a part or prepare the length of the Fortinet roll you need to fill up the "gap".
- Fix the welded mesh on the lower part (detail 1).
- Try to join each "horizontal" wire by means of the stainless steel clips type Fortinet.
- Insert the tension comb with the belt in top of the slope and tension by means of the excavator, parallel to the groundlevel.

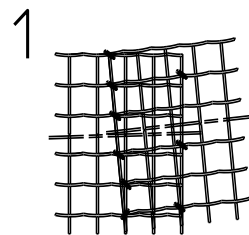

2

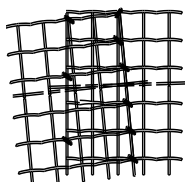

- Fix the end of the infill with the upper part, by joining almost every " horizontal" wire (detail 2).

3



- Fix all intermediate posts/fence (detail 3).

4. It is important to have some rigid ladders to allow labourers to work up to 2,5 meter high .
5. Never walk over the welded mesh when spread over the ground, except to join two rolls. Otherwise, each step damages/deforms the fence and will influence the look afterwards. Of course, this can be adjusted by means of the crimp tong but takes supplementary time afterwards. If there are undulations in the fence after fixing properly, they can be removed by means of the same crimp tong.

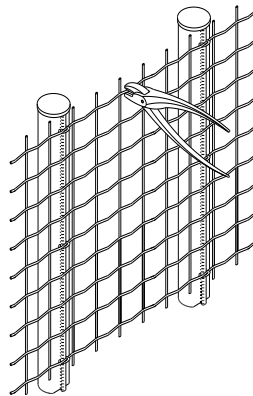

Crimp tong

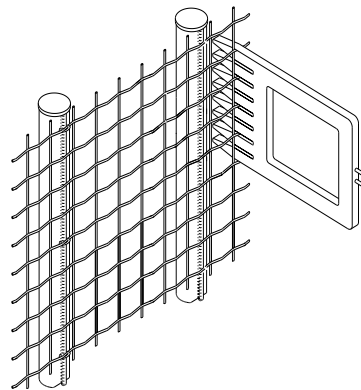

Tension fork

6. When interrupting erecting fence (for instance after a shift/before a weekend), always fix the last end of the welded mesh on the "last intermediate tension unit" with clips 10 to 15cm spacing between.
7. Prepare the fence line as straight levelled as possible and remove all dirt (rock blocs, wooden planks,...) over a width of about 3 meter in front of the posts: this decreases damages on the welded mesh and increases safety on the job, the speed and the end look of the fence.
8. In case of concrete on the lower part of the Bekaclip posts, clean them before everything is hardened, otherwise it will be difficult or impossible to install the clips properly.
9. If axe holes of the Fortinet Protect rolls are damaged during uncharging the containers, cut away two or three meshes. Keep in mind that, when fixing two rolls together, it is important that the join is as flat as possible .
10. If intermediate posts are not perfectly levelled, it is possible to adjust before fixing the mesh by means of the black small tension forks by pushing the posts to the left or to the right: this will upgrade the look afterwards .

11. Number of clips :

For a 2 meter high fence

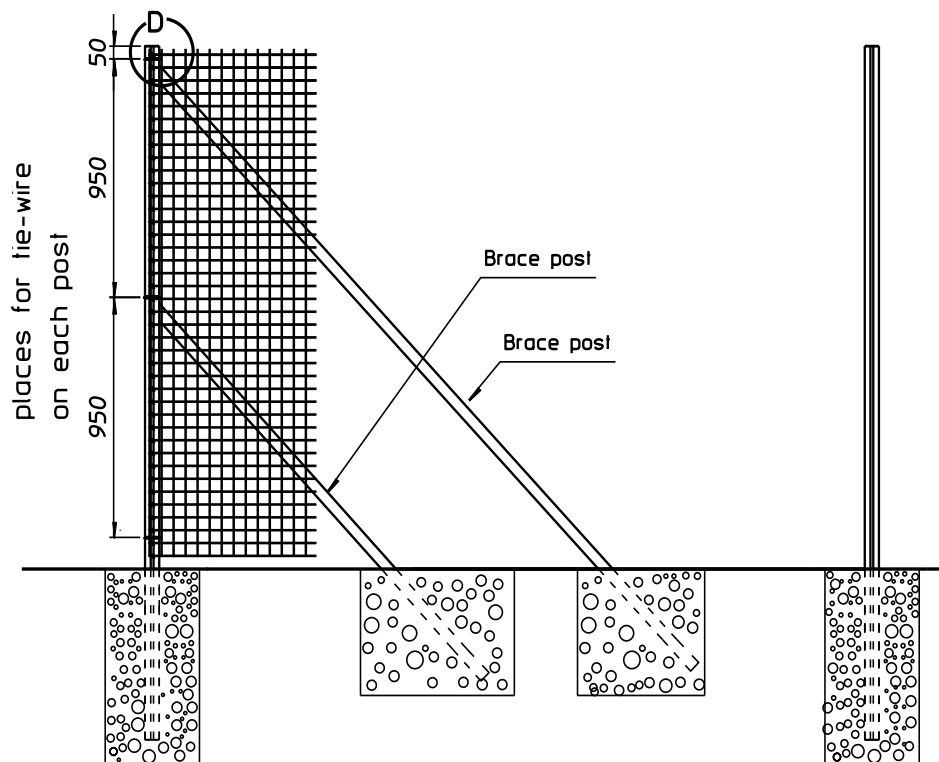
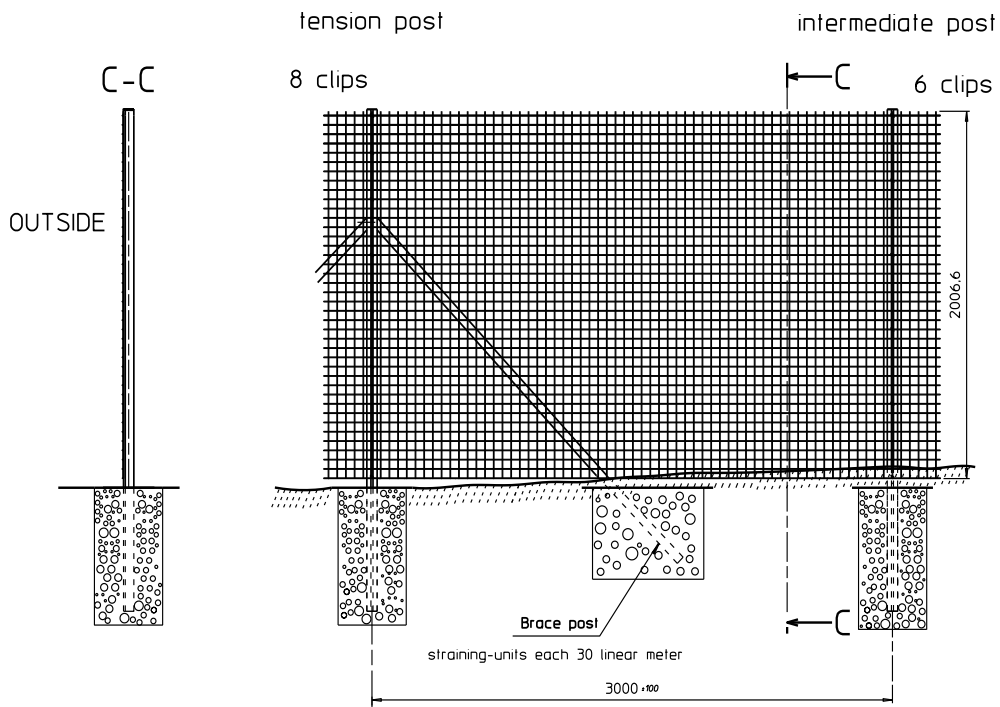

first & end-post
40 clips

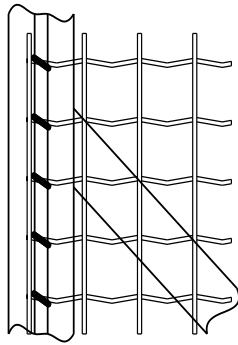

DETAIL D

to connect two rolls
41 clips

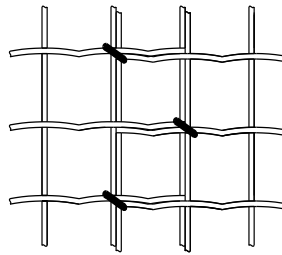

For a 2,5 meter high fence with extension arm :

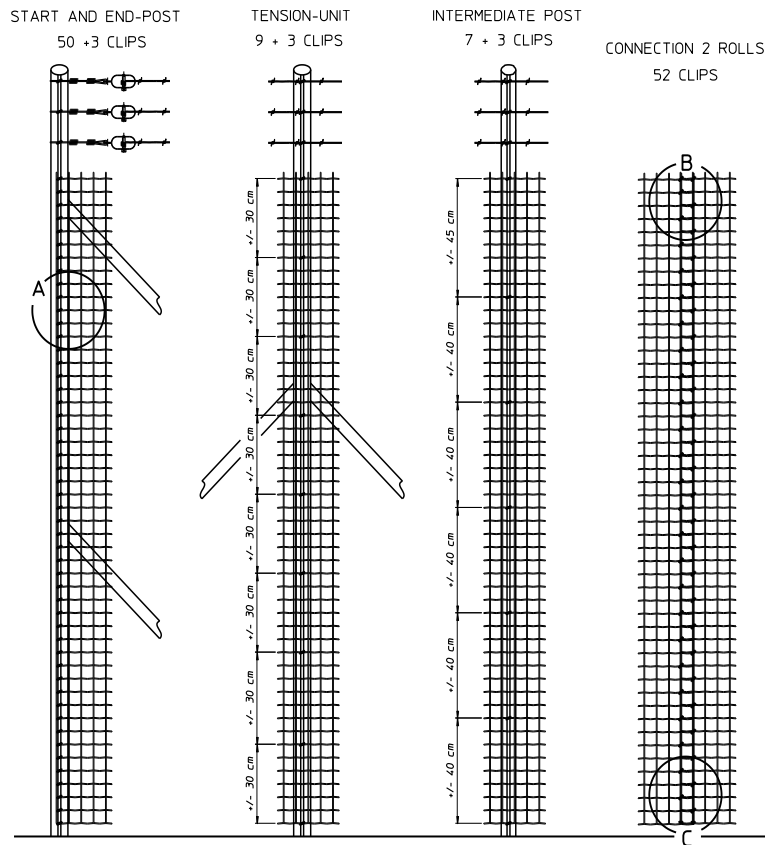

12. Unloading a container :

To avoid damage to the rolls, replace the standard flat forks on the forklift by round pointed beam.

Make sure the forklift can drive into the container to unload to unload. Try to organise a ramp for unloading the container.

Such a tool will increase the speed of unloading substantially.

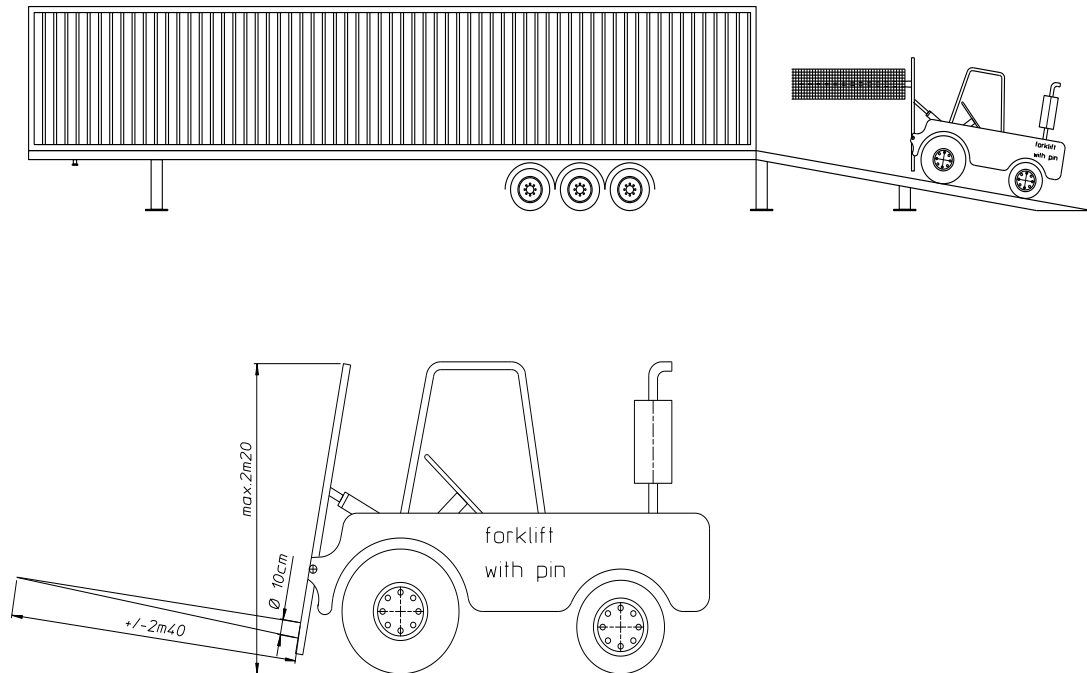

13. Verify the dimensions and capacities of the excavator:

This is an essential tool to tension in a proper way in all conditions and eliminates working with a winch. In the mean time, the workman with the excavator can transport the heavy rolls, level and backfill the perimeter area.

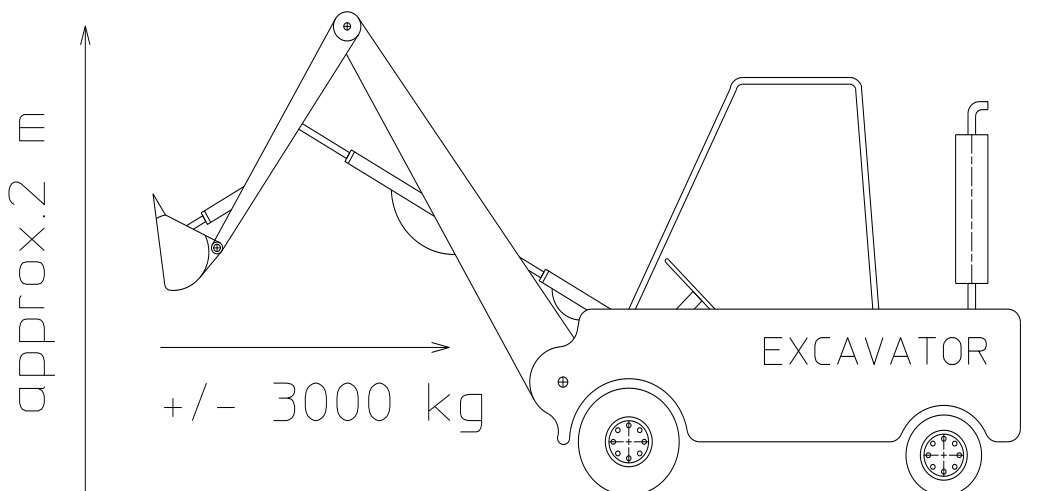

8. REPARATION OF FORTINET WELDED MESH

TOOLS

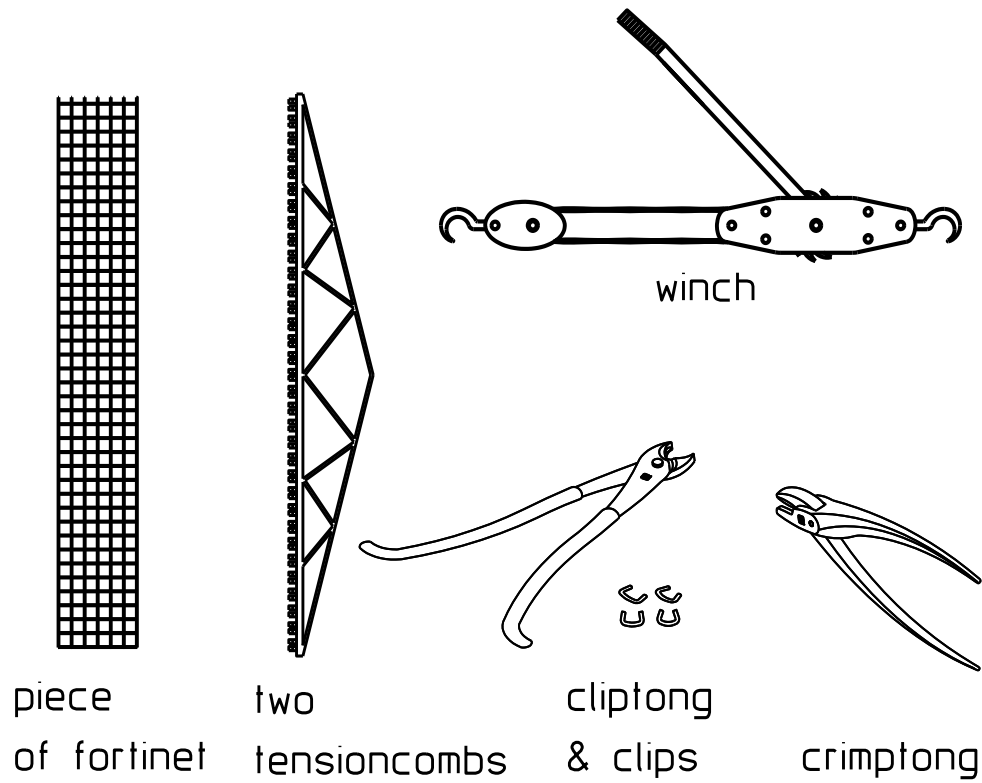

PROCEDURE

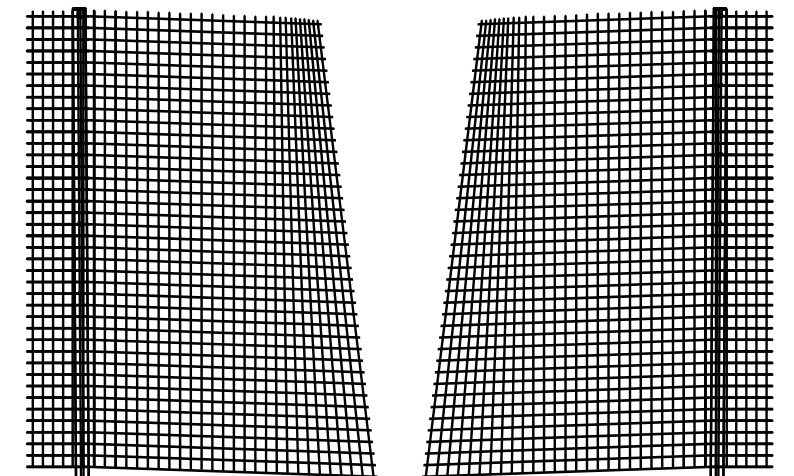

1. Problem of broken mesh

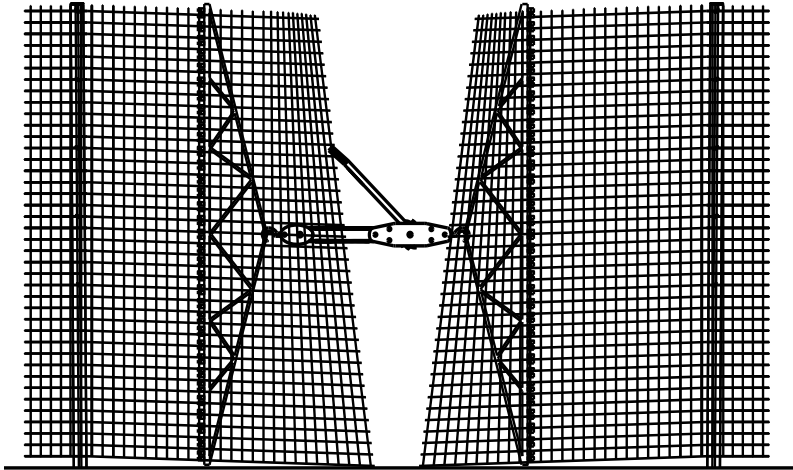

2. Hang on both sides of the mesh a tension comb as close as possible on the inside of the fence, connected with the winch.

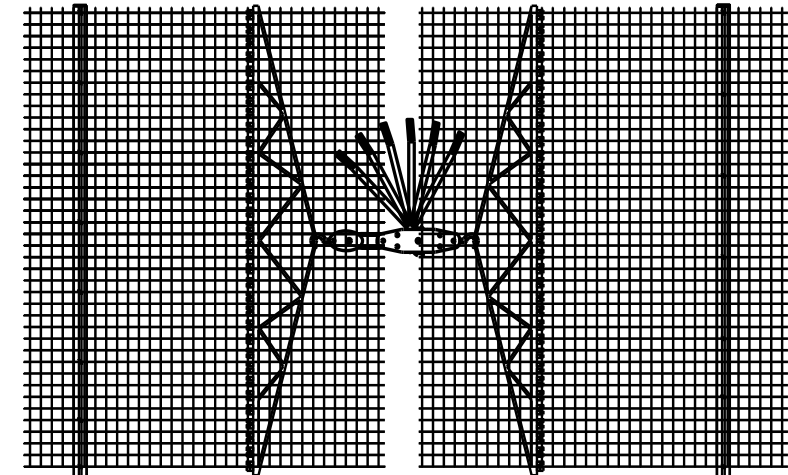

3. Pull both ends together by using the winch

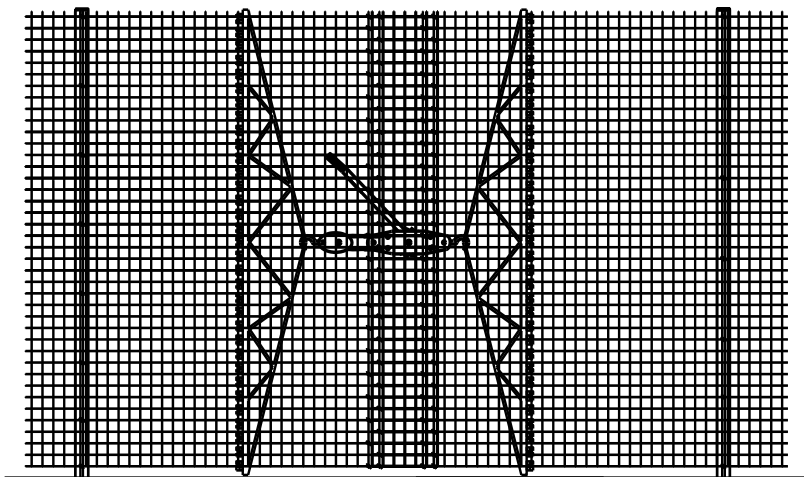

4. Adjust the pieces of Fortinet welded mesh and connect all parts using the Fortinet clips

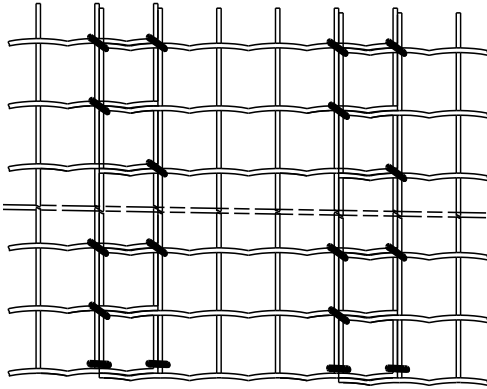

Detail: connection of supplementary piece of Fortinet

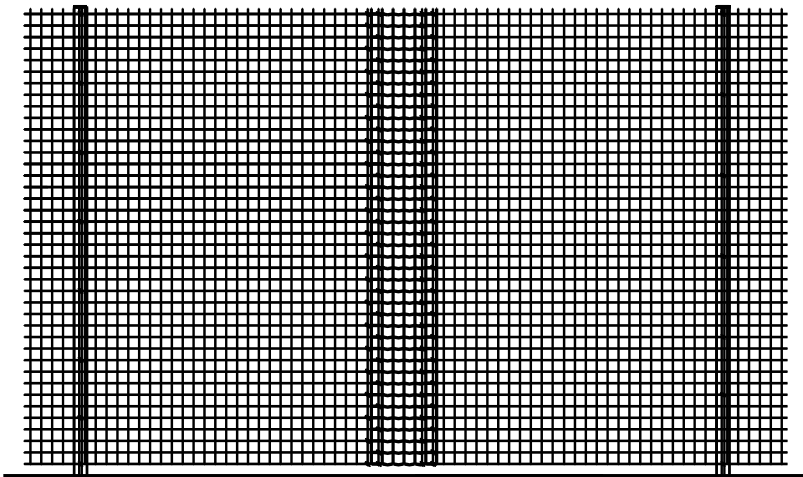

5. Remove winch and combs. Add supplementary tension in the fence using the crimp tong, by crimping full rows of meshes from top to bottom

9. FIXING OF Y-EXTENSION ARMS WITH BARBED WIRE AND CLIPPED RAZOR TAPE ON BEKACLIP POSTS

A. Fixation of the Y-extension arms on straight posts

Off the site

- Enter the Bekaclip post into the small part of the extension arm. If there is a hole diameter 8 mm in the Bekaclip post. This is the part of the post to be embedded into the concrete .
- Using the self drilling screws 4,8x25 mm, you also need a hard steel drive pen to prepare a hole, a specific bit WERA type 851/1 BDC f.i. and a drill and driver with variable speed (450..1500 r/min.) and adjustable torque (3Nm...10Nm).

On site

- Install the extension arm in top of the post .
- Using the self drilling screws 4,8x25 mm : you will need the same tooling as described above AND a contra block f.i. a hammer of min. 1.25kg), to prepare a hole in the extension arm to make drilling and screwing easier .

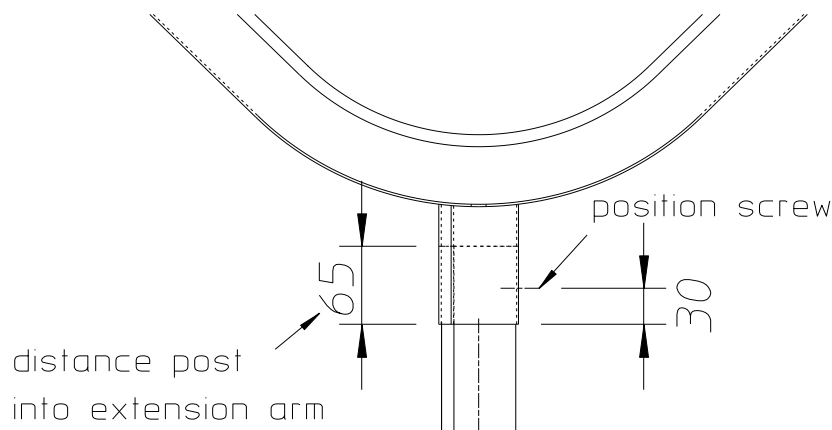

B. Fixation of the barbed wire on the Y-extension

- Unroll a 250 meter long coil of barbed wire in front of the fence.
- Fix the barbed wire on top of an Y-extension, +/- 3 cm beyond the top of the extension arm, at about 125 meter distance from the first post, there where you have brace posts.
- Turn the barbed wire around the Bekaclip extension arm and secure the fixation b.m.o. the standard stainless steel clip on the fixing strip.
- Fix a tensioner on both ends of the barbed wire, see drawing below, and tension the barbed wire properly.

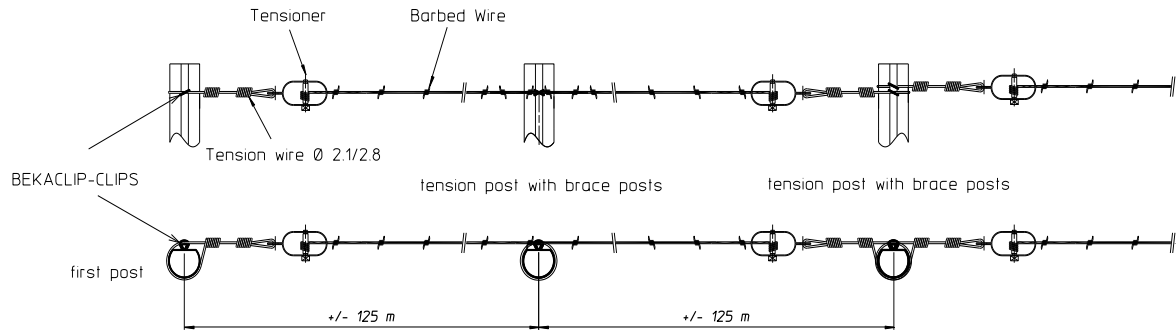

- Start with a second layer of barbed wire in the same way, taking into account a spacing of about 20 cm from the top layer.
- Do the installation of the barbed wire on both sites of the fence simultaneously to avoid sacks in the barbed wire rope or lower tension on one of both sides of the fence.

C. Installation & fixation of the concertina coil on top of the Y-extension arms

- necessary tools:
 - high truck with platform or hollow tube 12 meter long about 5 forks, 3 meter long, to be arranged locally
- using a high truck passing the fence:
 - whilst truck is moving slowly along the fence, have the coil extended and lay down on the barbed wire ropes over 12 meter
- using a hollow tube of >12 meter:
 - Extend the coil over 12 meter
 - Enter the tube throughout the axe hole of the coil
 - Fix start & end of the extended coil on the tube = 12 meter extended
 - Lift up the extended 12 meter long coil by means of minimum 5 forks & 5 people and drop the extended coil on the barbed wire ropes
- connection of two coils by means of 3 stainless steel clips
- connection of the coil on the barbed wire ropes: with about 27 stainless steel clips between two extension arms = join each contact point between razor tape and barbed wire.

